

Product datasheet

Specifications



circuit breaker EasyPact
CVS100B, 25 kA at 415 VAC, 100
A rating thermal magnetic TM-D
trip unit, 3P 3d

LV510307

Main

Range	EasyPact
Range Of Product	EasyPact CVS100...250
Product Name	EasyPact CVS
Device Short Name	CVS100B
Product Or Component Type	Circuit breaker
Device Application	Distribution
Poles Description	3P
Protected Poles Description	3D
Earth Leakage Protection (Vigi Add On)	Without
[In] Rated Current	100 A at 40 °C
Network Type	AC
Utilisation Category	Category A
[Icu] Breaking Capacity	40 kA Icu at 220/240 V AC 50/60 Hz conforming to IEC 60947-2 25 kA Icu at 380/415 V AC 50/60 Hz conforming to IEC 60947-2 20 kA Icu at 440 V AC 50/60 Hz conforming to IEC 60947-2
Trip Unit Name	TM-D
Trip Unit Technology	Thermal-magnetic
Trip Unit Rating	100 A at 40 °C
Protection Type	Short-circuit protection (magnetic) Overload protection (thermal)

Complementary

[Uimp] Rated Impulse Withstand Voltage	8 kV conforming to EN/IEC 60947-2
Network Frequency	50/60 Hz
Breaking Capacity Code	B
[Ics] Rated Service Breaking Capacity	15 kA at 440 V AC 50/60 Hz conforming to IEC 60947-2 25 kA at 380/415 V AC 50/60 Hz conforming to IEC 60947-2 40 kA at 220/240 V AC 50/60 Hz conforming to IEC 60947-2
Mechanical Durability	30000 cycles
Electrical Durability	12000 cycles 415 V In conforming to IEC 60947-2
Control Type	Toggle
Thermal Protection Adjustment Range	70...100 A
Long Time Pick-Up Adjustment Type Ir	Adjustable

Long Time Pick-Up Adjustment Range	0.7...1 x In
Long Time Delay Adjustment Type	Fixed
Instantaneous Pick-Up Adjustment Type II	Fixed
Instantaneous Pick-Up Adjustment Range	800 A
Contact Position Indicator	Yes
Mounting Support	Backplate
Mounting Mode	Fixed
Upside Connection	Front
Downside Connection	Front
Connections - Terminals	Screw connection
Connection Pitch	35 mm
Compatibility Code	CVS100
Width	105 mm
Depth	86 mm
Height	161 mm
Net Weight	1.5 kg

Environment

Standards	EN 60947-2 IEC 60947-2
Product Certifications	GOST IEC
Electrical Shock Protection Class	Class II
Pollution Degree	3 conforming to IEC 60664-1
IP Degree Of Protection	IP40
Ambient Air Temperature For Operation	-25...70 °C
Ambient Air Temperature For Storage	-50...85 °C

Packing Units

Unit Type Of Package 1	PCE
Number Of Units In Package 1	1
Package 1 Height	14.000 cm
Package 1 Width	13.400 cm
Package 1 Length	19.000 cm
Package 1 Weight	1.670 kg
Unit Type Of Package 2	S04
Number Of Units In Package 2	12
Package 2 Height	30.000 cm
Package 2 Width	40.000 cm
Package 2 Length	60.000 cm
Package 2 Weight	20.806 kg

Sustainability

Green Premium™ label is Schneider Electric's commitment to delivering products with best-in-class environmental performance. Green Premium promises compliance with the latest regulations, transparency on environmental impacts, as well as circular and low-CO₂ products.

Guide to assessing product sustainability is a white paper that clarifies global eco-label standards and how to interpret environmental declarations.

[Learn more about Green Premium >](#)

[Guide to assess a product's sustainability >](#)



Transparency RoHS/REACH

Well-being performance

Mercury Free

RoHS Exemption Information Yes

Certifications & Standards

Reach Regulation [REACH Declaration](#)

Eu RoHS Directive Compliant with Exemptions

China RoHS Regulation [China RoHS declaration](#)
Product out of China RoHS scope. Substance declaration for your information

Environmental Disclosure [Product Environmental Profile](#)

Weee The product must be disposed on European Union markets following specific waste collection and never end up in rubbish bins

Circularity Profile No need of specific recycling operations

Dimensions Drawings

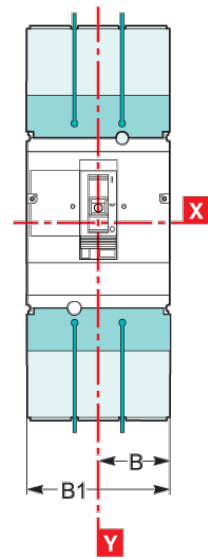
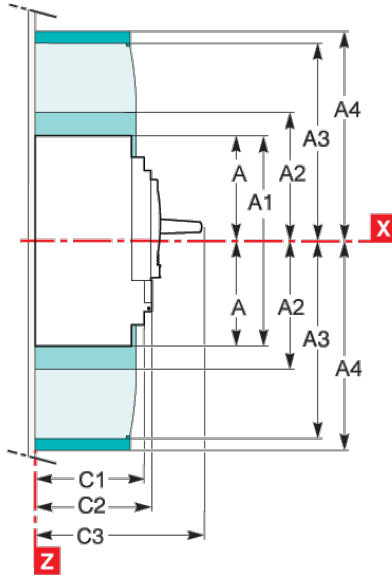
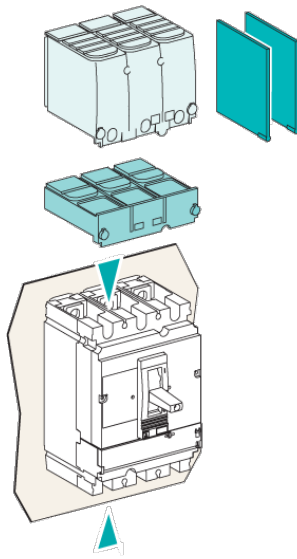

Type	A	A1	A2	A3	A4	A5	A6	A7	A8	A9	B	B1	B2	C1	C2	C3	E1
CMS100H60/250	80.5	161	64	146	170.5	155.5	236	169	226	353.5	52.5	165	140	81	66	111 ^Ø	62.5
CMS400/630	127.5	255	142.5	200	237	227.5	355	242.5	300	337	70	140	186	95.5	110	169	100
Type	E2	E3	E4	E5	E6	E7	E8	F1	F2	F3	G1	G2	G3	G4	G5	ØT	U
CMS100H60/250	125	70	140	137.5	200	145	215	35	17.5	70	65	75	18.5	23	17.5	24	y32
CMS400/630	200	113.5	227	200	300	213.5	327	45	22.5	80	-	-	-	-	32	y35	

Ø T=126mm for EasyPact CVS250MF

Assembly

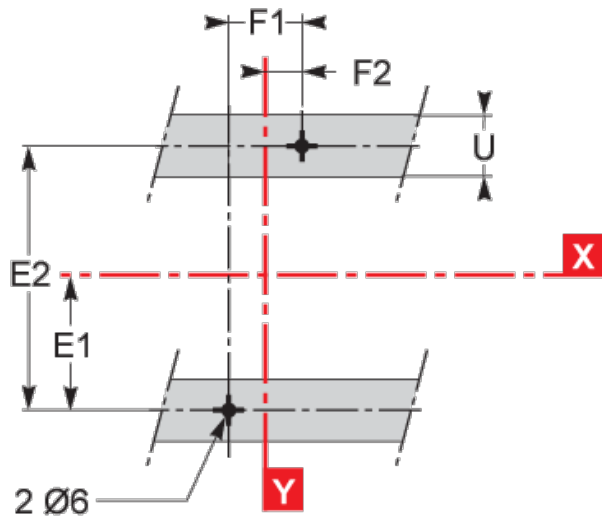
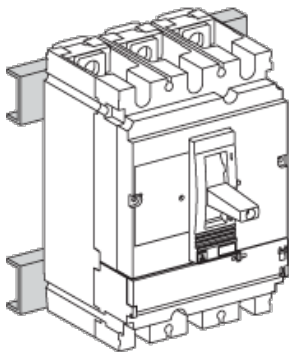
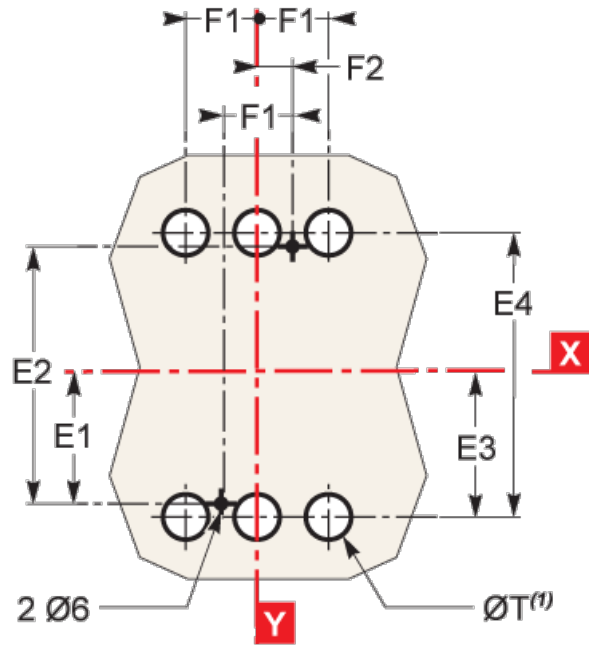
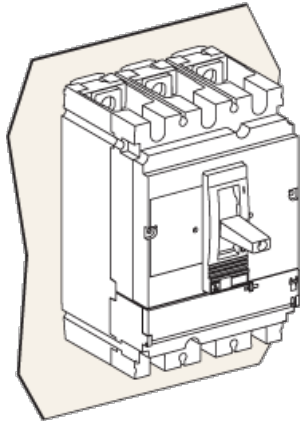

Type	A	A1	A2	A3	A4	A5	A6	A7	A8	A9	B	B1	B2	C1	C2	C3	E1
CMS100H160/250	80.5	161	64	140	170.5	155.5	226	109	220	253.5	52.5	105	140	81	86	111 ⁽¹⁾	82.5
CMS400/630	127.5	255	142.5	200	287	277.5	355	242.5	300	337	70	140	185	95.5	110	168	100
Type	E2	E3	E4	E5	E6	E7	E8	F1	F2	F3	G1	G2	G3	G4	G5	ØT	U
CMS100H160/250	125	70	140	137.5	200	145	215	95	17.5	70	55	75	13.5	33	17.5	34	y32
CMS400/630	200	113.5	227	200	300	213.5	327	45	22.5	90	-	-	-	-	32	y35	

⁽¹⁾ C3-126mm for EasyRect CYS250DF.

Performance Curves

